

Long and Short Radius 45°/ 90° Elbows

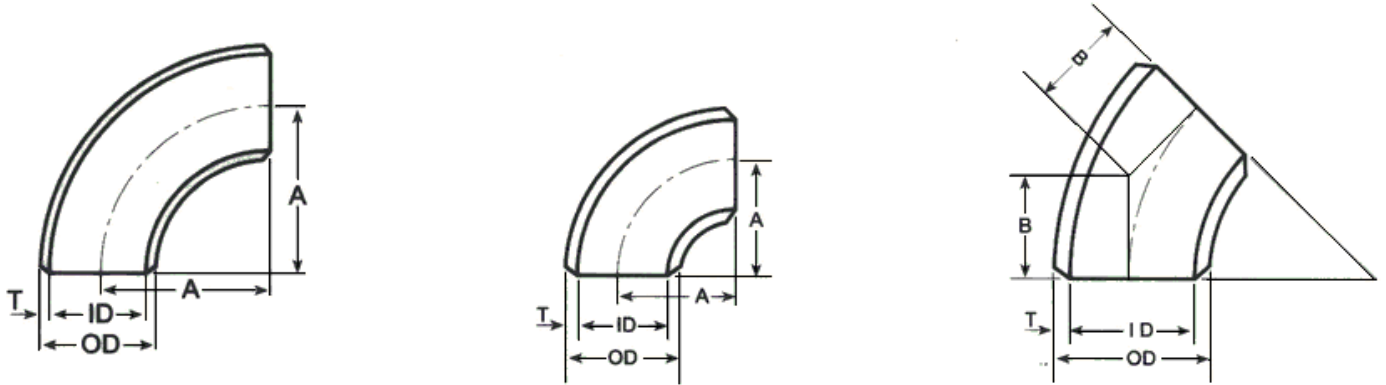

ANSI B16.9 B16.28 (in mm)

Nominal Pipe Size (NPS)	Outside Diameter at Bevel D	Center to End			
		Long Radius Elbows		Short Radius Elbows	
		90 degree. A	45 degree B	90 degree A	45 degree B
1/2	21.3	38.1	15.7	-	-
3/4	26.7	38.1	19.1	-	-
1	33.4	38.1	22.4	25.4	-
1-1/4	42.2	47.8	25.4	31.8	-
1-1/2	48.3	57.2	28.4	38.1	-
2	60.3	76.2	35.1	50.8	-
2-1/2	73.0	95.2	44.4	63.5	-
3	88.9	114.3	50.8	76.2	31.6
3-1/2	101.6	133.4	57.2	88.9	36.8
4	114.3	152.4	63.5	101.6	42.1
5	141.3	190.5	79.2	127.0	52.6
6	168.3	228.6	95.2	152.4	63.4
8	219.1	304.8	127.0	203.2	84.2
10	273.1	381.0	158.8	254.0	105.2
12	323.9	457.2	190.5	304.8	126.3
14	355.6	533.4	222.2	355.6	147.3
16	406.4	609.6	254.0	406.4	168.3
18	457.2	685.8	285.8	457.2	189.4
20	508.0	762.0	317.5	508.0	210.4
22	558.8	838.2	342.9	558.8	231.5
24	609.6	914.4	381.0	609.6	252.5
26	660.4	990.6	406.4	660.4	273.5
28	711.2	1066.8	438.2	711.2	294.6
30	762.0	1143.0	469.9	762.0	315.6
32	812.8	1219.2	501.6	812.8	378.1
34	863.6	1295.4	533.4	863.6	357.7
36	914.4	1371.6	565.2	914.4	378.8
38	965.2	1447.8	599.9	-	-
40	1016.0	1524.0	632.0	1016.0	420.8
42	1066.8	1600.2	660.4	1066.8	441.9
44	1117.6	1676.4	695.5	1117.6	462.9
46	1168.4	1752.6	726.9	-	-
48	1219.2	1828.8	759.0	1219.2	505.0
52*	1320.8	-	-	1320.8	547.1
54*	1371.6	2057.4	852.2	1371.6	568.1
56*	1422.4	2133.6	883.8	1422.4	589.2
60*	1524.0	2286.0	946.9	1524.0	631.3
66*	1676.4	2514.6	1041.6	-	-
68*	1727.0	2591	1073	1727	-
72*	1829.0	2743	1137	1829	-
76*	1930.0	2896	1199	1930	-
80	2032.0	3048	1263	2032	-